

Semifinals

Final

Semifinals

(x) MARJANOVIC Karlo CRO

MARJANOVIC K.(CRO)
PTF 4-2

213

SIVOSHELEZ A.(RUS)
PTF 6-3

310

(x) SIVOSHELEZ Aleksan RUS

(x) TSAKNAKIS Georgios GRE

Classification

- | |
|----------------------------|
| 1 MARJANOVIC Karlo CRO |
| 2 SIVOSHELEZ Aleksandr RUS |
| 3 TSAKNAKIS Georgios GRE |

LEGEND RSC: Win by Referee stops contest PTG: Win by Point gap SUP: Win by Superiority DSQ: Win by Disqualification DQB: Win by Disqualification for Unsportsmanlike behavior DWR: Win by double Withdrawal R: Round
(x)Seed PFT: Win by Final score GDP: Win by Golden points WDR: Win by Withdrawal PUN: Win by Punitive declaration DDB: Double disqualification for Unsportsmanlike behavior DDQ: Double Disqualification

Round of 16 Quarterfinals Semifinals Final Semifinals Quarterfinals Round of 16

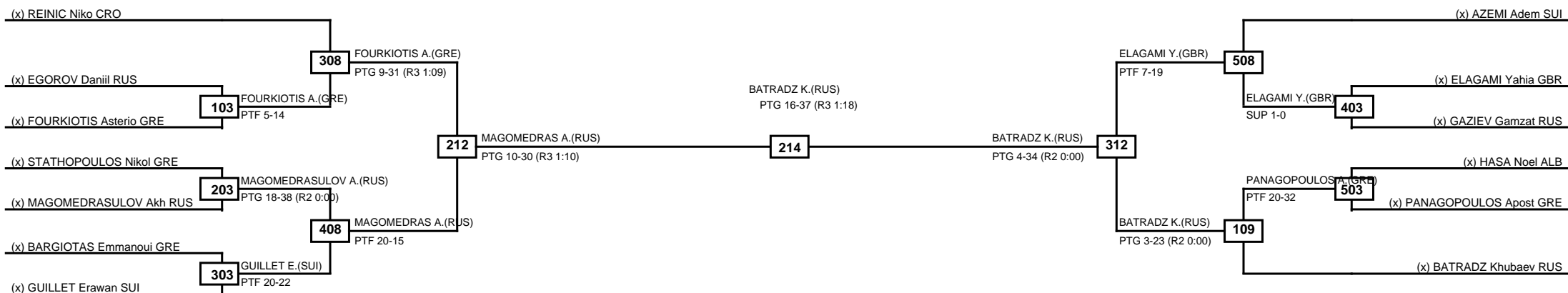

Classification
1 BATRADZ Khubaev RUS
2 MAGOMEDRASULOV Akhmed RUS
3 FOURKIOTIS Asterios GRE
3 ELAGAMI Yahia GBR

LEGEND RSC: Win by Referee stops contest PTG: Win by Point gap SUP: Win by Superiority DSQ: Win by Disqualification DQB: Win by Disqualification for Unsportsmanlike behavior DWR: Win by double Withdrawal R: Round
 (x)Seed PFT: Win by Final score GDP: Win by Golden points WDR: Win by Withdrawal PUN: Win by Punitive declaration DDB: Double disqualification for Unsportsmanlike behavior DDQ: Double Disqualification

Round of 16	Quarterfinals	Semifinals	Final
-------------	---------------	------------	-------

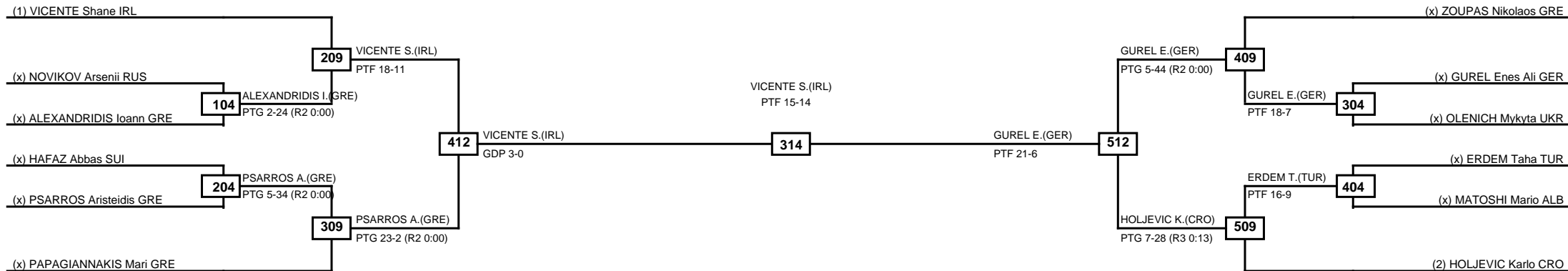

Classification
1 VICENTE Shane IRL
2 GUREL Enes Ali GER
3 HOLJEVIC Karlo CRO
3 PSARROS Aristeidis Nikolaos GRE

LEGEND	RSC: Win by Referee stops contest	PTG: Win by Point gap	SUP: Win by Superiority	DSQ: Win by Disqualification	DQB: Win by Disqualification for Unsportsmanlike behavior	DWR: Win by double Withdrawal	R: Round
(x)Seed	PFT: Win by Final score	GDP: Win by Golden points	WDR: Win by Withdrawal	PUN: Win by Punitive declaration	DDB: Double disqualification for Unsportsmanlike behavior	DDQ: Double Disqualification	

Round of 16 Quarterfinals Semifinals Final Semifinals Quarterfinals Round of 16

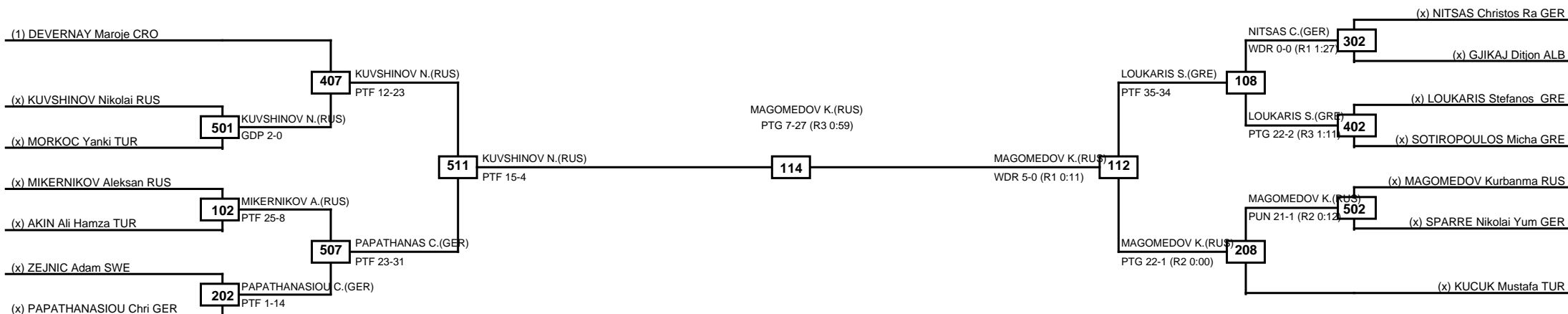

Classification
1 MAGOMEDOV Kurbanmagomed RUS
2 KUVSHINOV Nikolai RUS
3 LOUKARIS Stefanos Marinos GRE
3 PAPATHANASIOU Christos GER

LEGEND RSC: Win by Referee stops contest PTF: Win by Point gap SUP: Win by Superiority DSQ: Win by Disqualification DQB: Win by Disqualification for Unsportsmanlike behavior DWR: Win by double Withdrawal R: Round
(x)Seed PFT: Win by Final score GDP: Win by Golden points WDR: Win by Withdrawal PUN: Win by Punitive declaration DDB: Double disqualification for Unsportsmanlike behavior DDQ: Double Disqualification

Quarterfinals Semifinals

Final

Semifinals

Quarterfinals

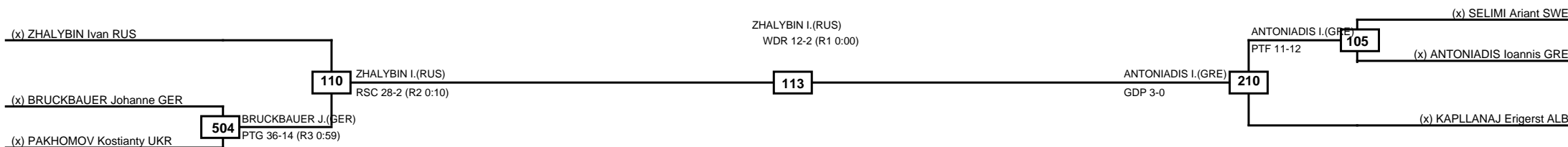

Classification
1 ZHALYBIN Ivan RUS
2 ANTONIADIS Ioannis GRE
3 BRUCKBAUER Johannes GER
3 KAPLLANAJ Erigerst ALB

LEGEND RSC: Win by Referee stops contest PTG: Win by Point gap SUP: Win by Superiority DSQ: Win by Disqualification DQB: Win by Disqualification for Unsportsmanlike behavior DWR: Win by double Withdrawal R: Round
 (x)Seed PFT: Win by Final score GDP: Win by Golden points WDR: Win by Withdrawal PUN: Win by Punitive declaration DDB: Double disqualification for Unsportsmanlike behavior DDQ: Double Disqualification

Round of 16 Quarterfinals Semifinals Final Semifinals Quarterfinals Round of 16

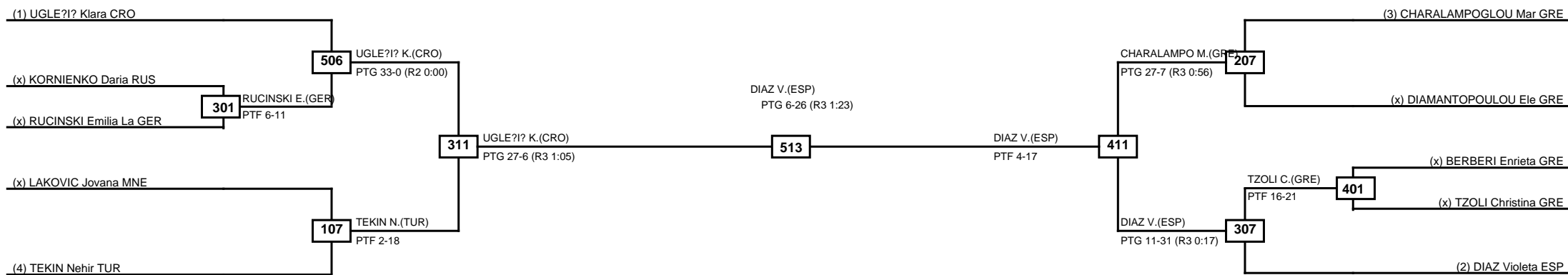

Classification
1 DIAZ Violeta ESP
2 UGLE? I? Klara CRO
3 TEKIN Nehir TUR
3 CHARALAMPOGLOU Maria Anna GRE

LEGEND RSC: Win by Referee stops contest PTG: Win by Point gap SUP: Win by Superiority DSQ: Win by Disqualification DQB: Win by Disqualification for Unsportsmanlike behavior DWR: Win by double Withdrawal R: Round
 (x)Seed PFT: Win by Final score GDP: Win by Golden points WDR: Win by Withdrawal PUN: Win by Punitive declaration DDB: Double disqualification for Unsportsmanlike behavior DDQ: Double Disqualification

Round of 16 Quarterfinals Semifinals

Final

Semifinals

Quarterfinals Round of 16

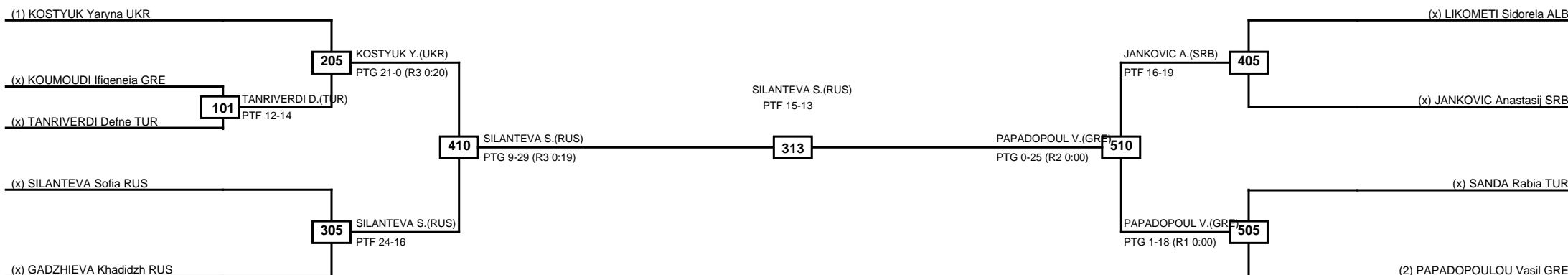

Classification
1 SILANTEVA Sofia RUS
2 PAPADOPOULOU Vasiliki GRE
3 KOSTYUK Yaryna UKR
3 JANKOVIC Anastasija SRB

LEGEND RSC: Win by Referee stops contest PTG: Win by Point gap SUP: Win by Superiority DSQ: Win by Disqualification DQB: Win by Disqualification for Unsportsmanlike behavior DWR: Win by double Withdrawal R: Round
 (x)Seed PFT: Win by Final score GDP: Win by Golden points WDR: Win by Withdrawal PUN: Win by Punitive declaration DDB: Double disqualification for Unsportsmanlike behavior DDQ: Double Disqualification

Round of 16 Quarterfinals Semifinals Final Semifinals Quarterfinals Round of 16

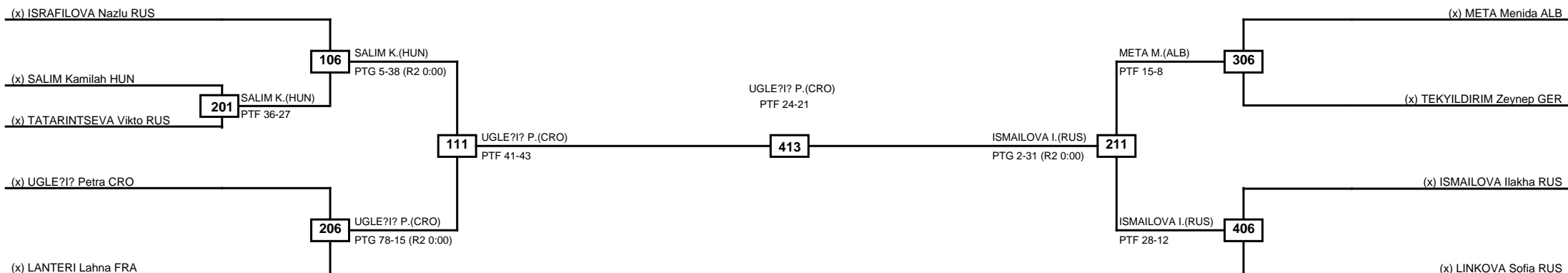

Classification
1 UGLEÁ IĀ† Petra CRO
2 ISMAILOVA Ilakha RUS
3 META Menida ALB
3 SALIM Kamilah HUN

LEGEND RSC: Win by Referee stops contest PTG: Win by Point gap SUP: Win by Superiority DSQ: Win by Disqualification DQB: Win by Disqualification for Unsportsmanlike behavior DWR: Win by double Withdrawal R: Round
 (x)Seed PFT: Win by Final score GDP: Win by Golden points WDR: Win by Withdrawal PUN: Win by Punitive declaration DDB: Double disqualification for Unsportsmanlike behavior DDQ: Double Disqualification